

MODEL 745-T

FOUR CHANNEL DIGITAL DELAY/ PULSE GENERATOR



The MODEL 745-T

Four high resolution delay channels
 0.25ps delay resolution
 <25ps RMS jitter max (5ps for short delay)
 20s delay range (relative/absolute reference)
 Three trigger sources: external, internal or command
 Positive or Negative trigger slope
 Single, Repetitive or Burst trigger mode
 Gate mode
 External trigger prescaler (pulse picking)
 Tunable output (magnitude 2-5V, width 100ns-10µs)
 50 Ω load
 T0 reference output
 Clock output
 Gate input
 High precision internal clock (OCXO 50ppb)
 USB
 Ethernet interface (Web page)

Options:

4 auxiliary high resolution delay channels (1.25ns, 2 to 5V Amplitude but common tuning)

The MODEL 745-T digital delay generator provides four independent high resolution digital delay channels. The rms jitter between the trigger and any outputs is 25ps + delay x 10⁻⁸ max. which ensures a high performance delay. The device can be triggered by different ways: External trigger via a BNC input, Internal trigger and Software command trigger, each one with repetitive, single and burst trigger modes.

CONTENT

1-	GENERAL INFORMATION.....	4
	<i>What do you need to get started.....</i>	5
	<i>Unpacking Caution.....</i>	5
	<i>Operating temperature.....</i>	5
	<i>Self-test.....</i>	5
	<i>The device software.....</i>	5
	<i>Power fuses.....</i>	5
	<i>RAM with battery back up.....</i>	5
2-	SPECIFICATIONS.....	6
3-	FRONT PANEL OVERVIEW.....	7
	<i>LCD screen.....</i>	7
	<i>RUN/STOP Button.....</i>	7
	<i>BNCs.....</i>	7
	<i>Optional BNC.....</i>	7
4-	REAR PANEL OVERVIEW.....	8
	<i>Power Switch.....</i>	8
	<i>T0 output.....</i>	8
	<i>Clock BNCs.....</i>	8
	<i>AUX BNCs.....</i>	8
	<i>Ethernet Port.....</i>	8
	<i>USB Port.....</i>	8
5-	MENU STRUCTURE (NAVIGATING THE MODEL 745-T).....	9
6-	OPERATING INFORMATION.....	14
	<i>Operating Principles.....</i>	14
	<i>Timing principle using external trigger.....</i>	16
	<i>Timing principle using internal trigger.....</i>	18
	<i>Timing principle using Burst mode.....</i>	19
7-	OPERATING EXAMPLE.....	20
	<i>Default value.....</i>	20
	<i>Initial setup.....</i>	20
	<i>Setting up the instrument (Recurrent mode).....</i>	20
	<i>Setting up the instrument (Single shot mode).....</i>	20
	<i>Setting up the instrument (Burst Mode).....</i>	20
	<i>Stop the generator.....</i>	21
8-	PROGRAMMING.....	22
	<i>Serial communication (USB port).....</i>	22
	<i>Ethernet connection/communication.....</i>	22
	<i>Command structure (Ethernet and USB connection).....</i>	22
	<i>Web Page control/communication.....</i>	29
9-	ANNEX A.....	30
10-	ANNEX B.....	32

EDITION

Ed.	Date	Description
1	07/09/2015	Creation
2	04/11/2015	Modification: channels T1-T8 become channels A-H

1- GENERAL INFORMATION

The MODEL 745-T device provides four high precision independent delay channels. Access to these four outputs (A-D) is given by four BNC connectors on the front panel. The achieved delay resolution is about 0.25ps, and trigger-to-channel jitter is less than 25ps (Annex B). A-D can deliver up to 5V, 2ns rise time max (9-Annex A), into 50Ω. Amplitude and width are adjustable on each output channel either programmed from the front panel or via Ethernet.

A T0 output pulse is also available. It gives a time reference for each generated delayed output.

This high accuracy and precision device is suitable for system/experiment in science or industry that requires reliable timing solution.

The MODEL 745-T also provides four optional delay channels to front panel E-H with a delay resolution of 1.25ns, trigger-to-channel jitter less than 50ps with a common 2 to 5V tunable amplitude.

The internal timebase reference is a OCXO with a stability of 50ppb.

The device offers three operating trigger modes, repetitive (internal or external source), single shot (internal, external or asynchronous source) and a burst mode (internal, external or asynchronous source).

A Web page (accessed via Ethernet link) provides a simple method to configure the settings for each channel, amplitude, width, trigger source, trigger mode and to control operation. You can save and recall settings.

A serial communication is also available via an USB port.

Instrument Options

745-4C-GOC	Standard device
745-8C-GOC	Extension to 8 channels (4 optional channels with 1.25ns resolution)

Package Contents

The box you receive should contain the following:

- MODEL 745-T Digital Delay Generator
- PDF user manual and Labview VIs can be downloaded at:
- <http://www.berkeleyelectronics.com/support>
- Certificate of calibration

BNC product:

For more information about BNC product see our web site: <http://www.berkeleyelectronics.com/>.

What do you need to get started

To set up and use the MOD745, you need the following items:

- MODEL 745-T Digital Delay Generator,
- MODEL 745-T user manual

Unpacking Caution

The MODEL 745-T is shipped in an antistatic package to prevent electrostatic damage to the device. Electrostatic discharge (ESD) can damage several components on the device. Remove the device from the package and inspect the device for loose components or any sign of damage. Notify BNC if the device appears damaged in any way.

Caution:

Before device plug in, be sure to set the right voltage with the line voltage selector. It operates from 90V to 240 V.

Do not apply any voltage to either the shields or the output BNCs.

Operating temperature

The MODEL 745-T can be operated where the ambient air temperature is 10°C to 35°C and can be stored in ambient temperature from - 10°C to + 60°C. The MODEL 745-T is cooled by air circulation.

Self-test

The unit model, firmware version, serial numbers and the result of self-test procedure will be displayed one minute after power on. After 30s if the test is good then “self-test” disappears and the device can be used. If the test is not ok then “self-test” stays displayed and the device is locked.

The device software

Labview Vi's are provided with the MODEL 745-T device. They allow users to control and/or configure the equipment as planned. These Vis can be integrated in a top-level Vi where several devices are controlled.

The communication is done with an Ethernet connection.

Power fuses

The MODEL 745-T is protected against short circuit by means of one fuse according to nameplate of the power supply (F2.5H250V).

RAM with battery back up

The MODEL 745-T has a RAM with battery backup in which settings of the instrument can be stored (Lithium battery ref 2032).

2- SPECIFICATIONS

Delays

Channels	4 independent delay outputs
Range	0 to 20 seconds
Resolution	0.25 ps
Jitter	25ps RMS + delay x 10^{-8} (external trigger to any output) Annex 20ps RMS + delay x 10^{-8} (Channel to channel) Annex < 5ps RMS for short delay (Channel to channel)
Accuracy	< 250ps + delay x 10^{-8}
Time base	200 MHz, 50 ppb

Trigger source

Internal 2 Timers tunable in Hz or ns	1Hz to 1MHz, 1Hz resolution 1 μ s to 4s, 5ns resolution
External	Repetition rate < 1MHz Prescaler : 1 to $2^{16}-1$ Trigger level, from 0.1 to 5V, Internal load: 50 Ω Positive or negative slope Minimum trigger delay < 60ns

Trigger mode

Single, repetitive or burst	
Burst specs.	Pulse number: 2 to $2^{16}-1$ Period: 1000ns to 1s

Gate Mode

2 settings:	General or Individual
Gate source	Active high, Rep rate <100kHz

Output A-D (T1-T4) BNC connector

Amplitude	2 to 5V, 0.1V resolution
Width	100ns to 10 μ s, 5 ns resolution
Load	50 Ω
Rise time	< 2ns max, 900ps typical
Fall time	< 5ns max, 2ns typical

Clock Input

Frequency	10 or 80 MHz, 50% duty cycle. Ask factory for custom clock frequency.
-----------	--------------------------------------------------------------------------

Clock Output

Frequency	10 or 80MHz (directly related to the input clock)
Signal	+/- 1 V, square

USB Port

Communication	serial, baudrate 38400
---------------	------------------------

User Memory

Up to 4 sets of MODEL 745-T parameters can be stored/recalled via Front Panel or Telnet

General specifications

Size	215 x 245 x 135 mm
Power	50 W – 110 to 240 V
LEDs	Orange: Trigger on

Software

Control panel Web page from embedded web server for IE, Firefox or Chrome

Options

745-8C: 4-auxiliary delay output extension

Delay

Channels:	4 independent delay outputs
Range:	0 to 20 seconds
Resolution:	1.25ns
Jitter:	50ps RMS + delay x 10^{-8} (External trigger to any output)
Accuracy:	< 1ns + delay x 10^{-8}

Output E to H (T5 to T8)

Amplitude:	2 to 5V
Width:	100 ns to 10ms; 5ns resolution
Load:	50 Ω
Rise and Fall time	< 5 ns
Connector:	BNC on front panel

3- FRONT PANEL OVERVIEW

The MODEL 745-T front panel is composed of several kinds of elements: the user interface which consists of a keyboard and an LCD display that allows the user to program various settings and to interact with the device in local mode, 4 status LEDs, BNC connectors.



Figure - 1. Front panel

LCD screen

The screen is a 4.3" touch screen.

RUN/STOP Button

Global RUN/STOP. It enables to RUN or STOP all output channels.

BNCs

One input Trigger, one Gate input and 4 independent output channels (A – D) are available. The output voltage is tunable from 2 to 5V for each output independently and each one has to be terminated in 50Ω .

The input Trigger BNC connector provides a trigger signal operating up to 50 kHz.

Optional BNC

The four optional output (E – H) connectors are 50Ω impedance with adjustable amplitude, delay and width.

4- REAR PANEL OVERVIEW

All optional output connectors/modules appear on that side of the device. The other features are listed below.



Figure - 2. Rear panel

Power Switch

The unit is turned on by depressing the Power button. The MODEL 745-T can be operated from 100 to 240V at a line frequency of 50-60Hz.

T0 output

A reference pulse output is available. It delivers a fixed amplitude pulse with adjustable width. Terminated in 50Ω.

Clock BNCs

Clock input and clock output connectors are available. The CLK IN connector accepts either 10MHz or 80MHz (or custom frequency) clock frequency. The clock output (CLK OUT) comes from the CLK IN connector or from the internal oscillator – if clock in signal not present.

AUX BNCs

The AUX connector is not used so far.

Ethernet Port

A RJ45 Ethernet connector is available to control the MODEL 745-T with a computer. See § 8-.

USB Port

A female USB connector can be available allowing serial communication with the MODEL 745-T. See Chapter 8 – Programming for command syntax.

5- MENU STRUCTURE (NAVIGATING THE MODEL 745-T)

A three level Menu is available:

- A main menu to display settings
- Sub-Menus to select the parameter to set
- Keyboard to set the new parameter value

With 8 channel option

Here is given a presentation of the display menu for a 8 Channel Unit.

From the main menu (Figure - 3) the user can access every MODEL 745-T settings by pressing the selected parameter zone.

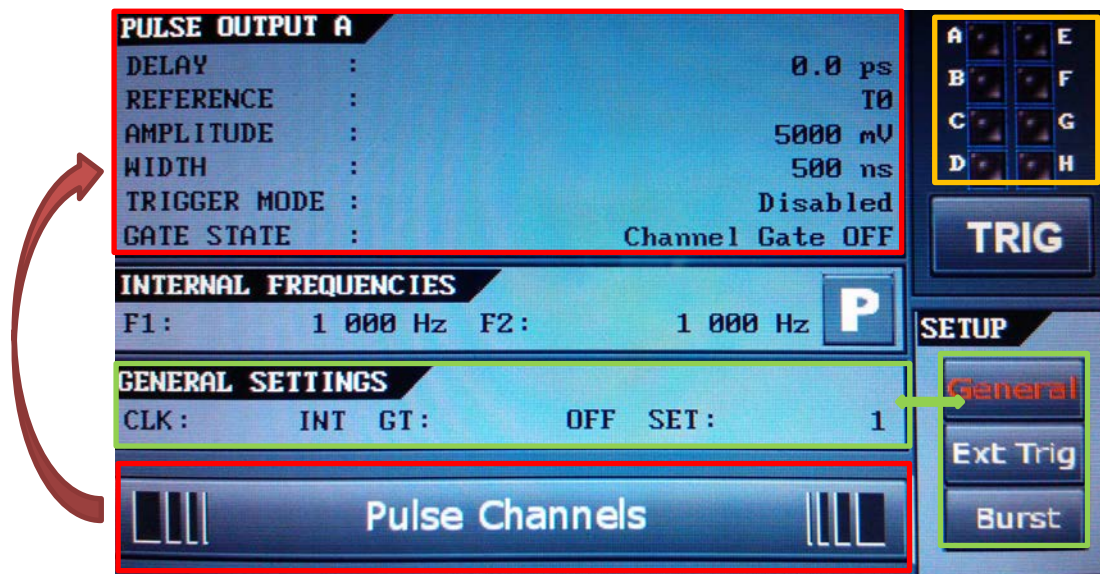

Figure - 3. Main Display

Main Display

Settings name	Description	Special
Pulse Output	Channel settings: trigger, amplitude, width, delay, reference, gate	Use the Pulse Channels bar to change the displayed channel
Internal Frequencies	Frequency or Period settings of internal trigger generator 1 & 2	Press the P button to display period settings
General	Clock, gate, store/recall and network settings	Press General in the Setup box to display the menu
External trigger	Trigger settings: threshold, slope and prescaler	Press Ext Trig in the Setup box to display the menu
Burst	Input clock setting: 10 or 80MHz.	Press Burst in the Setup box to display the menu
Trigger	Manual trigger button	
Channel status	Display the current channel status	Press the zone to clear channel status

Channel Setting Display

Channel Tx can be channel A to H.

Displayed name	Description and settings
TX TRIG=	To select Trigger source OFF= Trigger signal is inhibited IN1= Trigger signal coming from internal frequency 1 IN2= Trigger signal coming from internal frequency 2 EXT= Trigger signal coming from the front panel (TRIG IN) SS1= Single Shot trigger synchronous with internal freq. 1 SS2 = Single Shot trigger synchronous with internal freq. 2 SSE= Single Shot trigger synchronous with trigger input LSS = Software Single Shot trigger BST = Pulse train Trigger sync. With internal freq. or trigger input
TX RET=	To select the channel delay reference: T0 and A to H
TX Delay=	To adjust Output pulse delay of channel (A to D 1ps resolution display, E to H 1.25ns resolution display).
TX Ampl=	To adjust Output pulse amplitude of channel A to H.
TX Width=	To adjust Output pulse width of channel TX
TX Gate	To set Channel Gate mode On or Off (available if general Gate mode is set to "Channel Gate") of Channel A to H
RETURN MENU	To Return to main menu

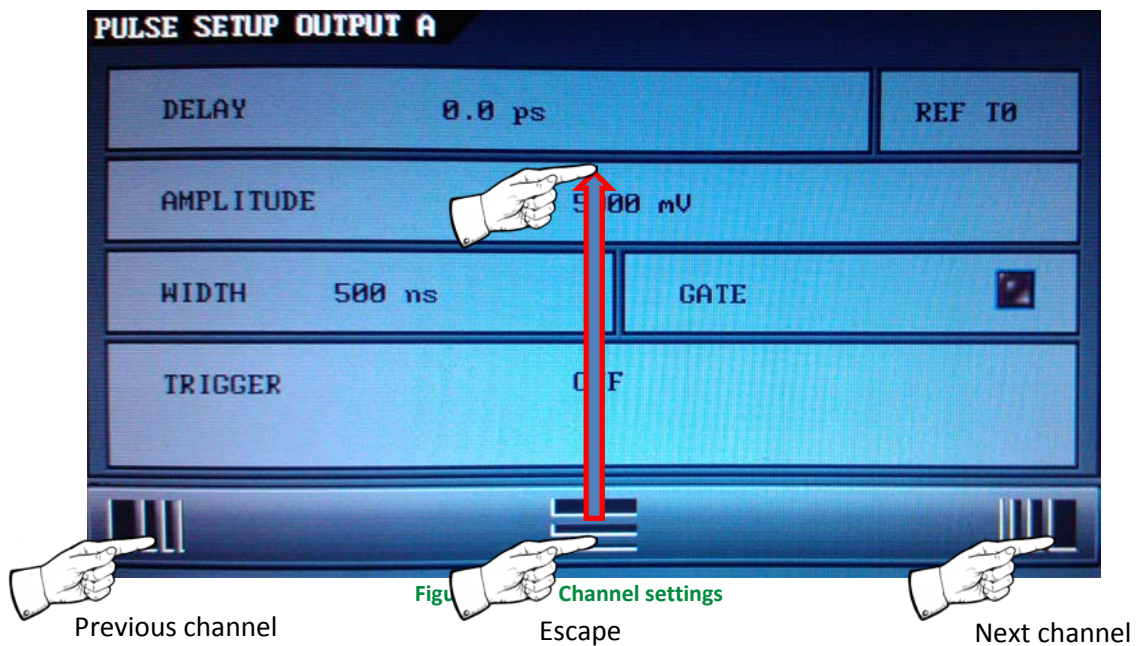

Note:

To escape from a submenu and go back to the main menu (RETURN MENU item in tables), the user has to touch the bottom bar center and slide up his finger (see Figure - 4).

To generate a pulse with a Single Shot setting (SS1, SS2, SSE or LSS), the user has to press the TRIG button displayed on the general menu.

Internal Frequency Display

Displayed name	Description and settings
Frequency 1	Frequency of internal trigger generator 1.
Frequency 2	Frequency of internal trigger generator 2.
Period 1	Period of internal trigger generator 1.
Period 2	Period of internal trigger generator 2.
RETURN MENU	To return to main menu

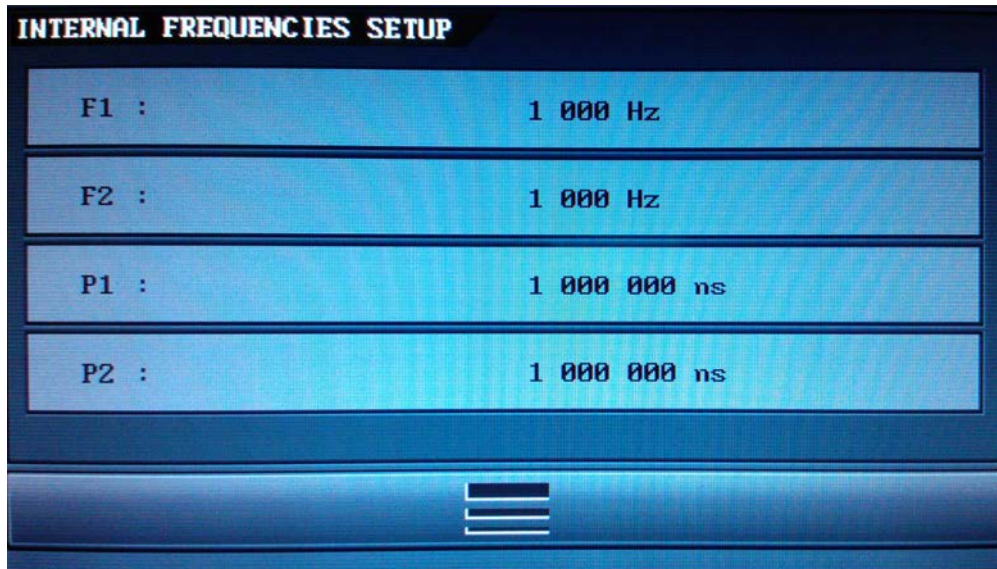

Figure - 5. Frequency settings

Note:

Changing a frequency setting will change automatically the associated period setting and conversely.

General settings

Displayed name	Description and settings
Ext Clock	Input clock setting: 10 or 80MHz.
Gate Mode	To select the Gate mode General gate: to aim every outputs Channel gate: to set individual behavior for each channels (independent Gate modes set in each Tx sub-menu)
Store x	To store current MODEL 745-T configuration in conf x (x=1 to 4)
Recall x	To recall conf x MODEL 745-T configuration
RETURN MENU	To return to main menu



Figure - 6. General settings 1

Note:

To access to the Ethernet parameters the user has to press the item on the right end of the bottom bar.

Displayed name	Description and settings
IP ADDRESS	Set the instrument's IP address
NET MASK	Set the instrument's IP mask
GATEWAY ADDRESS	Set the instrument's IP gateway
USE DHCP	YES (automatic IP address assignment) or NO (for manual IP assignment)
LANGUAGE	Select French or English language for menu
RETURN MENU	To Return to main menu

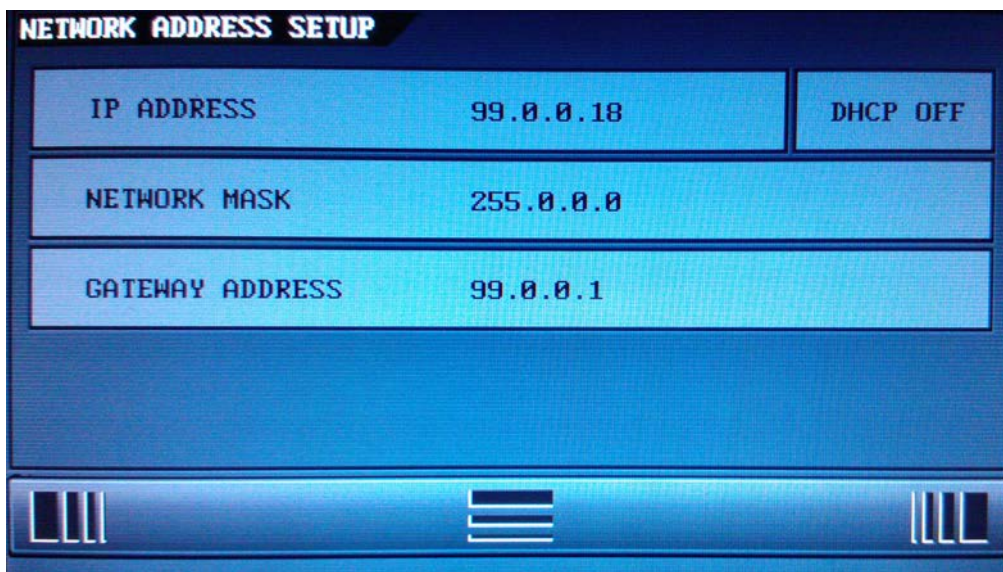

Figure - 7. General settings 2 - Network

External Trigger settings

Displayed name	Description and settings
Polarity	To trig on rising edge or on falling edge value of the Trig Ext input
Threshold	To adjust the threshold value of the Trig Ext input
Prescaler	To prescale the Trig Ext input frequency by a factor N (N = 1 to 2 ¹⁶ -1)
RETURN MENU	To return to main menu

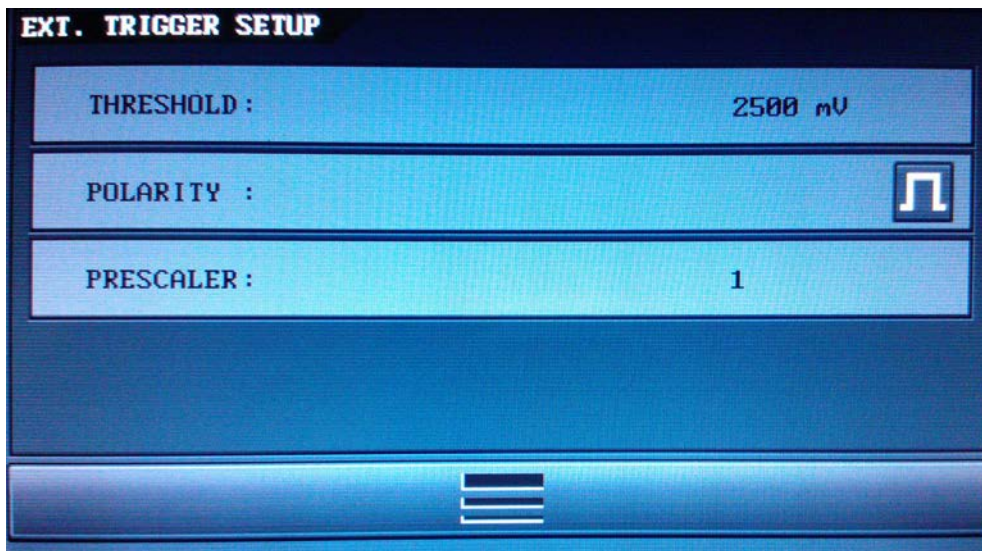

Figure - 8. External trigger settings

Burst Mode Settings

Displayed name	Description and settings
Burst Trigger	To select the trigger source : Int, Ext or manual
Pulse Number	To select the pulse number in each burst to generate (from 2 to 2 ¹⁶ -1)
Pulse Period	To select the period between burst pulses (from 1000ns to 1s)
RETURN MENU	To return to main menu

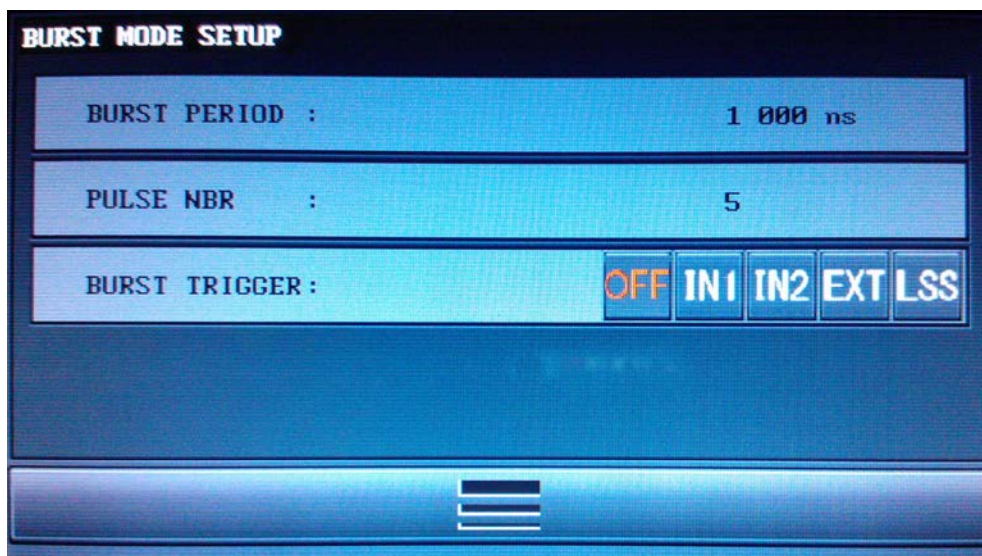

Figure - 9. Burst mode settings

6- OPERATING INFORMATION

Operating Principles

The principle of the programmable delay generator is described in the figure below:

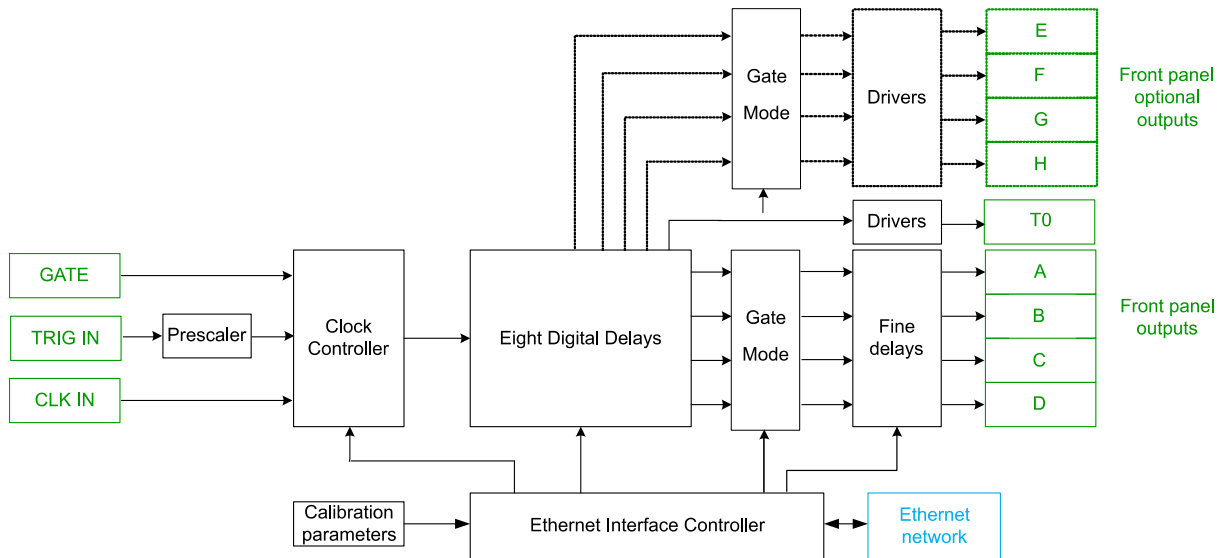

Figure - 10. Principle

Trigger source can be provided by the TRIG IN input, by an internal trigger, by a software command trigger. Repetitive, single shot trigger and burst modes are available with internal and external sources. An asynchronous single shot and burst mode are also available.

Repetitive triggers

When the external trigger source is selected a rising edge on "TRIG IN" starts a delay sequence. The sequence is depicted on Figure - 12. It has to be noticed that a Prescaler value can be used to divide the Trig Ext input signal frequency.

To get this feature, the user has to select 'EXT' as trigger source on the device via the front panel or via remote control (web page, Ethernet link).

If the internal trigger source is selected, the user can specify the needed trigger source via the front panel or via remote control (web page, Ethernet link). 2 frequency generators derived from input clock can be used as repetitive triggers: IN1 and IN2 corresponding to programmable Frequency 1 and 2. The use of internal trigger is depicted on Figure - 14. Frequency generation restarts when a push on the ESC button is detected while Frequency/Period menu is displayed.

Note: The internal period P1 et P2 can only be increment by step of 5ns.

Single Shot triggers

3 single shot modes are available: one synchronous to the external source (SSE), one to an internal source (SS1 synchronous to Frequency 1, SS2 synchronous to Frequency 2) and the last, an asynchronous one (LSS).

Each single shot mode is triggered by a software command. Software trigger command is available either via remote control or via front panel.

Single shots synchronous to external source is depicted on Figure - 12. The same principle can be applied to any of the internal sources.

Burst mode

The Burst mode is defined by its trigger source (internal, external, software / single shot or repetitive), its pulse number in each burst and the period between pulses. A pulse train can be independently set and defined on each channel: amplitude, width and delay are defined in the corresponding channel menu. An example of Burst mode is depicted on Figure - 15.

To generate a burst on a specified channel, first, the user has to configure the Burst mode itself (trigger, pulse number and pulse period) and then select “Burst (BST)” in the trigger source selection of the concerned channel.

Output channels

A T0 output pulse is the time reference of the delay output. It is generated for each selected trigger. Each output delayed pulse values A to D can be independently tuned in level, absolute or relative delay and width. All values (delay, delay reference, level, width, gate) are saved in memory except the trigger source.

Each output delayed pulse values E to H can be independently tuned in absolute or relative delay and width. All values (delay, delay reference, width, gate) are saved in memory except the trigger source. Calibration parameters are saved onboard.

After the power on, all trigger sources are off.

It has to be noticed that several output channels can only be triggered by the same source, that is to say an internal OR external source.

Gate mode

Each channel can be independently or simultaneously “gated” by the Gate in input signal. A Gate menu is available in the main menu of the MODEL 745-T device and in each Tx sub-menu. 2 different modes can be selected in the general Gate menu:

- 1 “GENERAL” mode to gate simultaneously all channels,
- 1 “CHANNEL” mode to gate independently each channel by setting in each Tx sub-menu the desired Gate state ('1' active, '0' inactive).

Configuration summary

On Figure - 11 is presented a functional diagram of the device. The different operation modes are illustrated.

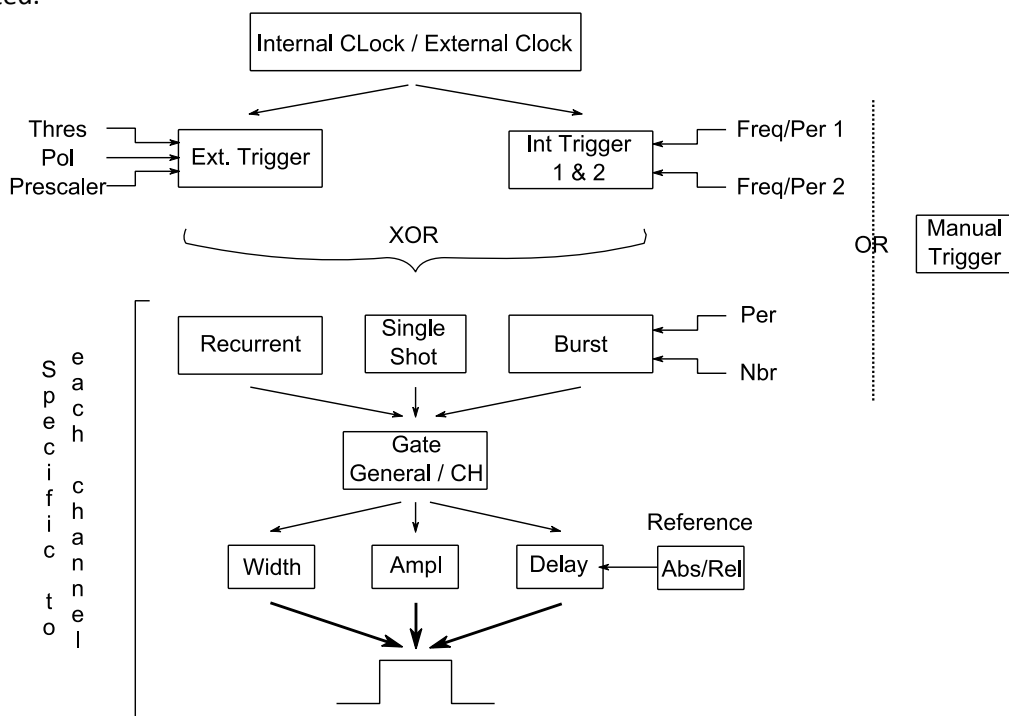

Figure - 11. Functional Diagram

Timing principle using external trigger

When the device is in a rest state (no current output signals), a rising edge on a trigger starts a delay sequence. The trigger comes from TRIG IN, or from a software command trigger (depending on the selected channel source).

The sequence includes two external trigger phases:

- After an insertion delay (<65ns), a pulse appears on each channel after a specified delay
- At the end of sequence, after the last delayed pulse, the delay generator is ready for repetitive trigger mode.

When a sequence is in progress, the instrument does not respond to a trigger event.

The MODEL 745-T must be configured (trigger, delay, etc.) before starting any sequences.

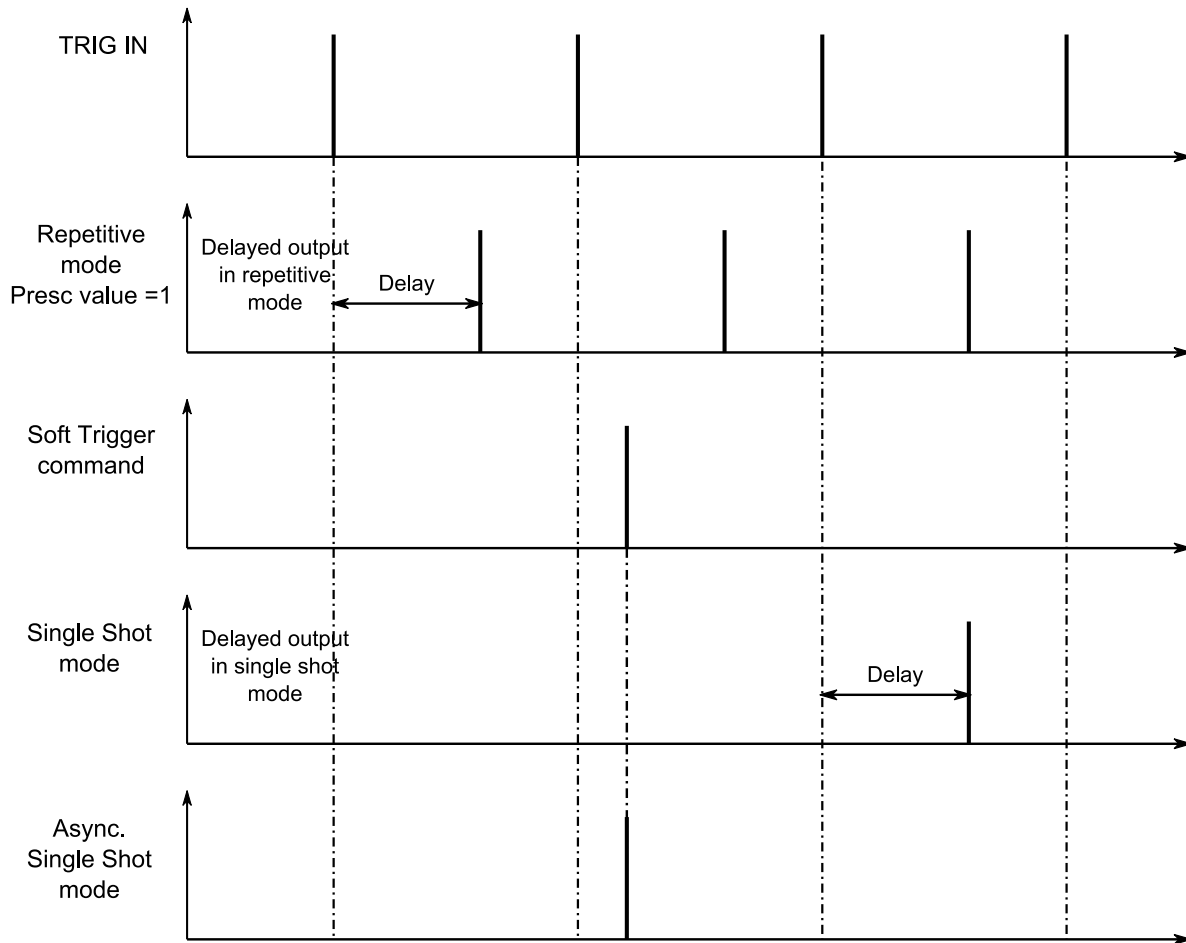

Figure - 12. External Trigger Timing

In response to an input pulse the device can generate a single delayed output (single shot) or repetitive delayed output (repetitive mode with a Trig In prescaler value = 1). As explain before, the single shot pulse is conditioned by the soft trigger command.

The use of the Prescaler value is depicted on Figure - 13. A Channel trigger source is set to external trigger.

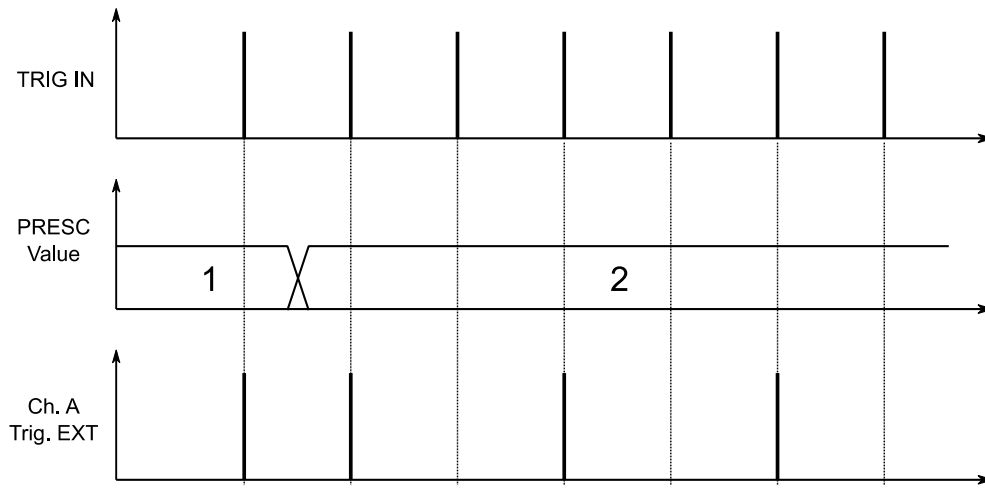

Figure - 13. Prescaler value

Timing principle using internal trigger

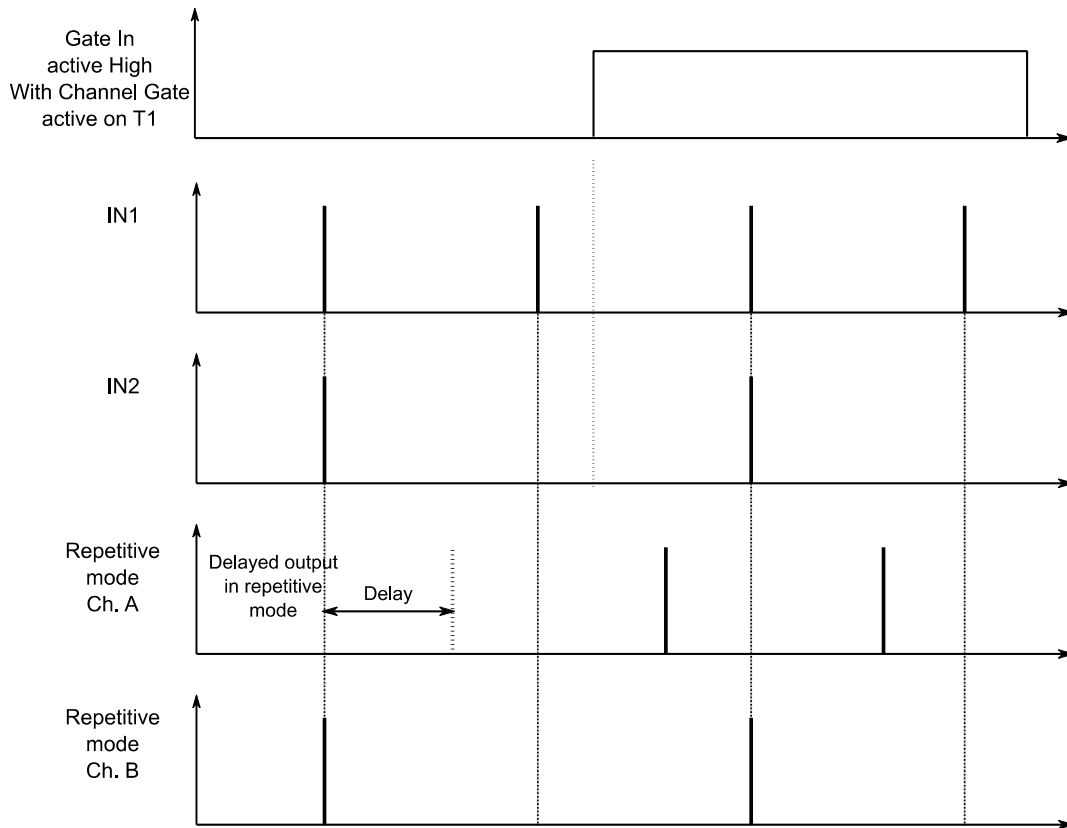

Figure - 14. Internal Trigger Timing

In Internal trigger mode, two tunable frequencies are available (IN1 and IN2). On Figure - 14, T1 output uses IN1 trigger with a specified delay of 0ps and B output uses IN2 trigger with a non-null delay.

The MODEL 745-T must be configured (trigger, delay, etc.) before starting any sequences. The individual Channel Gate Mode is also depicted on Figure - 14. It is obtained by setting general Gate Mode to "CHANNEL" and channel A Gate mode to "ON". The result is that the Gate In signal allows the pulse output of the channel A.

The width parameter doesn't appear on these two Figures (Figure - 12, Figure - 14). It has to be noticed that the frequency f used as repetitive input trigger (internal or external) and the maximum width of a corresponding output channel T_x are linked by:

$$MaxWidth Tx = \frac{1}{4f}$$

Timing principle using Burst mode

Each Channel can be independently set to Burst mode. In the following example Burst trigger has been set to IN1, Burst pulse number to 5 and Burst period to TB

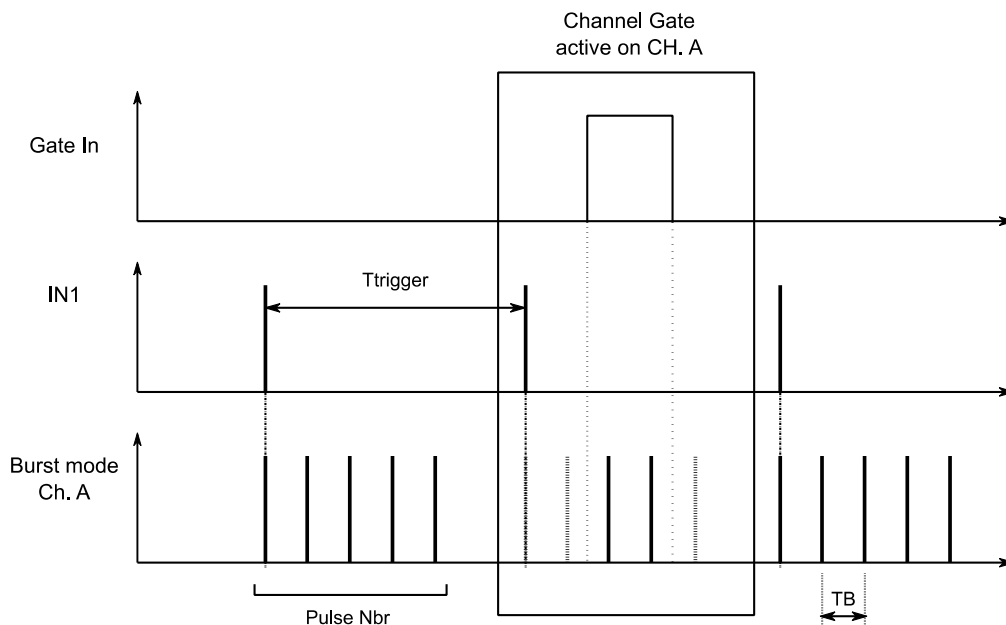

Figure - 15. Burst Mode Timing

The minimal burst period value is 1000ns. But it has to be noticed that this value depends on the Burst trigger period value and on the Burst pulse number.

$$TB_{min} = \frac{T_{trigger\ min}}{Pulse\ Nbr}$$

So, to get a $TB_{min} = 1000ns$ we can configure the device as follows:

- Pulse nbr max = 5
- $T_{trigger\ min} = 5000ns$

As depicted on Figure - 15, in the case of a generation of pulse train (Burst Mode) on a channel, the Gate In signal can allow some pulses among the pulse train.

It has to be noticed that when a delay D is specified on a channel using Burst mode as trigger mode, the MODEL 745-T manages the delay generation according to that rule:

- If delay $D > TB - 15ns$, the delay generation is shared between the delay register specific to the channel ($D_{chan} = TB - 15ns$) and the delay register associated to the burst trigger generation ($D_{BST} = D - TB + 15ns$).
- If delay $D \leq TB - 15ns$, the delay generation is managed as usual, that is to say by using the selected channel delay register.

To summarize: $D = D_{chan} + D_{BST}$ when $D > TB - 15ns$.

When several channels are using Burst mode as trigger mode and one of the delay specified leads to the D_{BST} register use ($D > TB - 15ns$), the D_{BST} value will be ignored (each channel will be delayed by D_{BST}).

7- OPERATING EXAMPLE

Default value

These values are the one stored by default:

- IP: 99.0.0.18
- Gateway: 99.0.0.01
- NetMask: 255.0.0.0
- Frequency1: 1000Hz
- Frequency2: 1000Hz
- TX Level: 5V, Width: 200ns.

Initial setup

Turn on the Model 745T with the rear panel power switch.

After 30 seconds, the following information are displayed:

```
MOD745   Sn xxxxx,4 V1  
SELF TEST
```

Setting up the instrument (Recurrent mode)

The aim is to set a repetitive frequency of 1000Hz to output pulse A, with an amplitude of 4V and a width of 1 μ s. Use the touch screen to configure the settings as following:

- Go to the internal frequency display
- Set Freq 1 to 1000Hz and return to the main menu
- Go the channel setting display and select channel A
- Set amplitude to 4V and width to 1 μ s
- Select IN1 as trigger source.

As soon as A is set to IN1, the main display LED of A will be on indicating that there is an output signal on A connector.

With an oscilloscope you can check the channel A.

Measurement should be:

Rectangular shape with repetitive frequency =1000 Hz, Amplitude= 4.0V, Width = 1.0 μ s.

Setting up the instrument (Single shot mode)

The procedure explained before can be followed up to the trigger choice. 3 single shot modes (external: SEXT, internal: SS1 and SS2, asynchronous: LSS) can be set. Once the single shot trigger mode is set, the user has to send a software command to trigger the single shot output pulse. To send this software command, 3 ways are available:

- Via the front panel: in the general menu, by pressing the TRIG button
- Via a telnet command, by sending the 'RUN' command to the device
- Via the web page, by pressing the 'manual trigger' button in the Trigger menu

Setting up the instrument (Burst Mode)

The aim is to set channel A in Burst mode to get:

- a 5V, 200ns width, 0ns delay pulse
- 100Hz IN1 trigger source
- Burst period 100000ns, pulse number = 10

First the user has to configure the F1 frequency to 100 Hz and then the Burst Mode itself. That is to say, set in the Burst Mode menu:

- Burst Trigger: IN1
- Burst Period: 100000

- Burst pulse number: 10

Once this has been done, the user has to set the width, delay and trigger source (BURST) in the A channel sub-menu.

The device will start to generate the requested pulse train.

Stop the generator

To stop the generation of that repetitive pulse, you have to set A trigger to OFF value. This will switch off the corresponding LED.

With an oscilloscope you can check if the output signal is switch off.

8- PROGRAMMING

Serial communication (USB port)

Generality

To access to MODEL 745-T via USB port, you have to configure the connection as follows:

- Baud rate: 38400
- Data bits: 8
- Stop Bit: 1
- Parity: None
- Flow control: None

Ethernet connection/communication

Generality

For connection over a LAN, you have to do the following:

- Connect the instrument to the LAN physically,
- In the graphical user interface, specify the LAN address,
- On the control PC, enter the instrument's IP address,
- After the connection has been established, the following commands can be used to modify the settings:
 - Set's the instrument's IP address with: IP XXX.XXX.XXX.XXX
 - Query's the instrument's IP address with: IP? ⇒ :IP XXX.XXX.XXX.XXX
 - Set's the instrument's IP mask with: NM XXX.XXX.XXX.XXX
 - Query's the instrument's IP mask with: NM? ⇒ :NM XXX.XXX.XXX.XXX
 - Set's the instrument's IP gateway: GW XXX.XXX.XXX.XXX
 - Query's the instrument's IP gateway with: GW? ⇒ :GW XXX.XXX.XXX.XXX

About Telnet Ports

3 ports can be used to configure the communication link and/or the μ controller used to communicate.

- Port 4000: general communication port
- Port 4001: re-initialization communication port. Used to reinitialize the communication between μ C and PC. Used in case of frozen device.
- Port 4002: force reset the μ C. Used in case of frozen device.

Command structure (Ethernet and USB connection)

Each command description is composed at least of some of the following items (all commands are used in a telnet prompt):

- Full command syntax,
- Form Set / Query,
- Brief description,
- Parameters,
- RST value,
- Specified limits.
- Example.

Note: in the following commands, instead of using A to H channel syntax, the user will use T1 to T8 syntax. To address a command to the channel A, the user will specify T1 instead of A in the command.

***IDN?**

Syntax: *IDN?
 Form: Query
 Description: Queries instrument identification. Answer gives instrument model, serial number and firmware version.
 Parameter: -
 RST value: -
 Example: BNC,MODEL 745,53901/F,V1.1
 Instrument model: MOD745
 Serial number: 53901,
 Channel number: F => 4 active channels (FF => 8 active channels)
 Software version: 1.1

BURST TRIG

Syntax: BTRIG Source
 BTRIG? source
 Form: Set & Query
 Description: Trigger source for Burst mode: internal, external or local
 Parameter: Source: IN1, IN2, EXT, SSL
 RST value: -
 Example: Set external trigger source: BTRIG EXT
 Query: BTRIG? => :BTRIG EXT

BURST PULSE PERIOD

Syntax: PERIOD PB, T
 PERIOD? PB
 Form: Set & Query
 Description: Set Burst period
 Parameter: PB
 T: period in ns (5ns resolution)
 RST value: -
 Specified limit: 1000 ns to 1s
 Example: PERIOD PB, 1000
 PERIOD? PB=> :PER 1000

BURST PULSE NUMBER

Syntax: BPULSE N
 BPULSE?
 Form: Set & Query
 Description: Set the number of pulses in a burst
 Parameter: N : Number of pulses
 RST value: -
 Specified limit: 2 to $2^{16}-1$ (depending on trigger source period and Burst period)
 Example: BPULSE 1000
 BPULSE? => :BPULSE 1000

GENERAL GATE MODE

Syntax: GGLOBAL mode
GGLOBAL?
Form: Set & Query
Description: General Gate mode status
Parameter: mode: OFF, ON and CH
RST value -
Example: Set : inhibit all outputs : GGLOBAL ON
Query: GGLOBAL? => :GGLOBAL ON

CHANNEL GATE MODE

Syntax: GCHAN Tx, value
GCHAN? Tx
Form: Set & Query
Description: Individual channel Gate mode status
Parameter: Tx: T1 to T4 (or 1 to 8 for 8 channel)
Value: ON, OFF
RST value -
Example: Set : T1 channel mode On : GCHAN T1, ON (GENERAL GATE MODE has to be set to CH to activate this setting)
Query: GCHAN? T1 => :GCHAN T1, ON

RELATIVE DELAY

Syntax: DELAY Tx,Ti, *delaytime*
DELAY? Tx
Form: Set & Query
Description: Delay time of channel Tx relative to channel Ti (reference channel) is set to *delaytime* picosecond
Parameter: Tx: channel number 1 to 4 (or 1 to 8 for 8 channel)
Ti: channel number 0 to 4 (or 0 to 8 for 8 channel)
Tn and Ti have to be different
delaytime: picosecond delay
RST value -
Specified limit 0 to 19 999 999 999 999 picoseconds
Example: Set : program 1ns to channel 2 relative to channel 1 : DELAY T2, T1, 1000.75
Query: DELAY? T2 => :DELAY T2, T1, 1000.75

Note : By using the Web page or Telnet command to configure the device, user can specify delay with 0.25ps resolution.

ABSOLUTE DELAY

Syntax: ABSDELAY? Tx
Form: Query
Description: Absolute delay time of channel Tx in ps
Parameter: Tx: channel number 1 to 4 (or 1 to 8 for 8 channel)
RST value -
Specified limit -
Example: Query: ABSDELAY? T2 => :DELAY T2, 5000.75

TRIG

Syntax: TRIG Tx,DEC
TRIG? Tx

Form: Set & Query

Description: Tx trigger mode selection: set trigger mode to internal, external, manual or off.

Parameter: Tx: channel number 1 to 4 (or 1 to 8 for 8 channel)
DEC: trigger mode : IN1, IN2, EXT, SS1, SS2, SSE, LSS, BST, OFF

RST value off

Example: Internal mode to channel 2 : TRIG T2,IN1
Query mode to channel 2: TRIG? T2 => :TRIG T2,IN1

AMPLITUDE

Syntax: AMPL Tx, mV
AMPL? Tx

Form: Set & Query

Description: Tx channel voltage level setting

Parameter: Tx: channel number 1 to 4 (or 1 to 8 for 8 channel)
mV: Volt Amplitude in millivolt

RST value -

Specified limit 2000 to 5 000 mV

Example: 2.5 V to channel 4: AMPL T4,2500
Query mode to channel 4: AMPL? T4 => :TRIG T4,2500

WIDTH

Syntax: WIDTH Tx,W
WIDTH? Tx

Form: Set & Query

Description: Channel Tx width setting

Parameter: Tx: channel number 1 to 4
W: width ns

RST value -

Specified limit Channel T0 to T4 : 100 to 10 000 ns
Channel T5 to T8 : 100 to 10 000 000ns

Example: 250 ns to channel 4: WIDTH T4,250
Query mode to channel 4: WIDTH? T4 => :WIDTH T4,250

EXT TRIG THRESHOLD

Syntax: STRIG mV
STRIG?

Form: Set & Query

Description: Set and Query trigger threshold voltage

Parameter: mV: Threshold level in millivolt

RST value -

Specified limit 100 to 5 000 mV

Example: 2.5 V: STRIG 2500
Query mode: STRIG? => : 2500

EXT TRIG POLARITY

Syntax:	POLAR Edge POLAR?
Form:	Set & Query
Description:	Edge: Rising Edge or Falling Edge
Parameter:	Edge: R_E or F_E
RST value	-
Specified limit	R_E or F_E parameters
Example:	Falling Edge: POLAR F_E Query mode: POLAR? :F_E

EXT TRIG PRESCALER

Syntax:	TPRESC Value TPRESC??
Form:	Set & Query
Description:	Set prescaler value to divide Trig In source frequency
Parameter:	Value: Trig In prescaler value
RST value	-
Specified limit	from 1 to $2^{16}-1$
Example:	4: TPRESC 4 Query mode: TPRESC? :4

FREQUENCY

Syntax:	FREQ Fx, F FREQ? Fx
Form:	Set & Query
Description:	Set internal mode frequency
Parameter:	Fx : F1, F2 F: frequency Hz
RST value	-
Specified limit	1 Hz to 1 MHz
Example:	FREQ F1, 1000 FREQ? F1=> :FREQ 1000

PERIOD

Syntax:	PERIOD Px, T PERIOD? Px
Form:	Set & Query
Description:	Set internal mode period
Parameter:	Px : P1, P2 T: period in ns (5ns resolution)
RST value	-
Specified limit	1000ns to 4s
Example:	PERIOD P1, 1000 PERIOD? P1=> :PER 1000

CLKEXT

Syntax: CLKEXT F
 CLKEXT? F
 Form: Set & Query
 Description: Set external PLL frequency
 Parameter: F: external PLL frequency: CLK10, CLK80
 RST value -
 Specified limit -
 Example: CLKEXT CLK10
 CLKEXT? => :CLKEXT: CLK10

RUN

Syntax: RUN
 Form: Set
 Description: Software trigger
 Parameter: -
 RST value -
 Example: RUN

STORE

Syntax: STORE n
 Form: Set
 Description: To store MODEL 745-T current configuration
 Parameter: n: configuration number
 RST value -
 Specified limit 0 to 3
 Example: STORE 1

RECALL

Syntax: RECALL n
 Form: Set
 Description: To recall a MODEL 745-T configuration previously stored
 Parameter: n: configuration number
 RST value -
 Specified limit 0 to 3
 Example: RECALL 1

STAT

Syntax: STAT CLEAR
STAT? xxx

Form: Set & Query

Description: Equipment information

Parameter: CLK: INTERNAL / EXTERNAL
TRIG: trigger channel 1 to 4 states
PLL: PLL oscillator state
OSC: gated oscillator state

RST value Off

Example: STAT CLEAR : clear the information

STAT? CLK => :STAT CLK,INTERNAL
STAT? TRIG => :STAT TRIG,1,0,0,1 Channel 1 and 4 trig on mode internal, external or manual
STAT? PLL => PLL oscillator default,
STAT? OSC => gated oscillator default

IP address

Syntax: IP x.x.x.x
IP?

Form: Set & Query

Description: IP Address

Parameter: x.x.x.x : IP address

RST value Off

Example: IP 172.17.23.6
IP? => :IP 172.17.23.6

Net mask address

Syntax: NM x.x.x.x
NM?

Form: Set & Query

Description: Net mask Address

Parameter: x.x.x.x : NW address

RST value Off

Example: NW 255.255.0.0
NW? => :NW 255.255.0.0

GW address

Syntax: GW x.x.x.x
GW?

Form: Set & Query

Description: GW Address

Parameter: x.x.x.x : GW address

RST value Off

Example: GW 172.17.23.6
GW? => :GW 172.17.23.6

Web Page control/communication

The user can open a web page to control the MODEL 745-T device via Internet Explorer, Firefox or Chrome (last versions supported). To access the web page, the IP address of the device has to be typed in the navigator address field. Once that is done, the user should access to the following page.

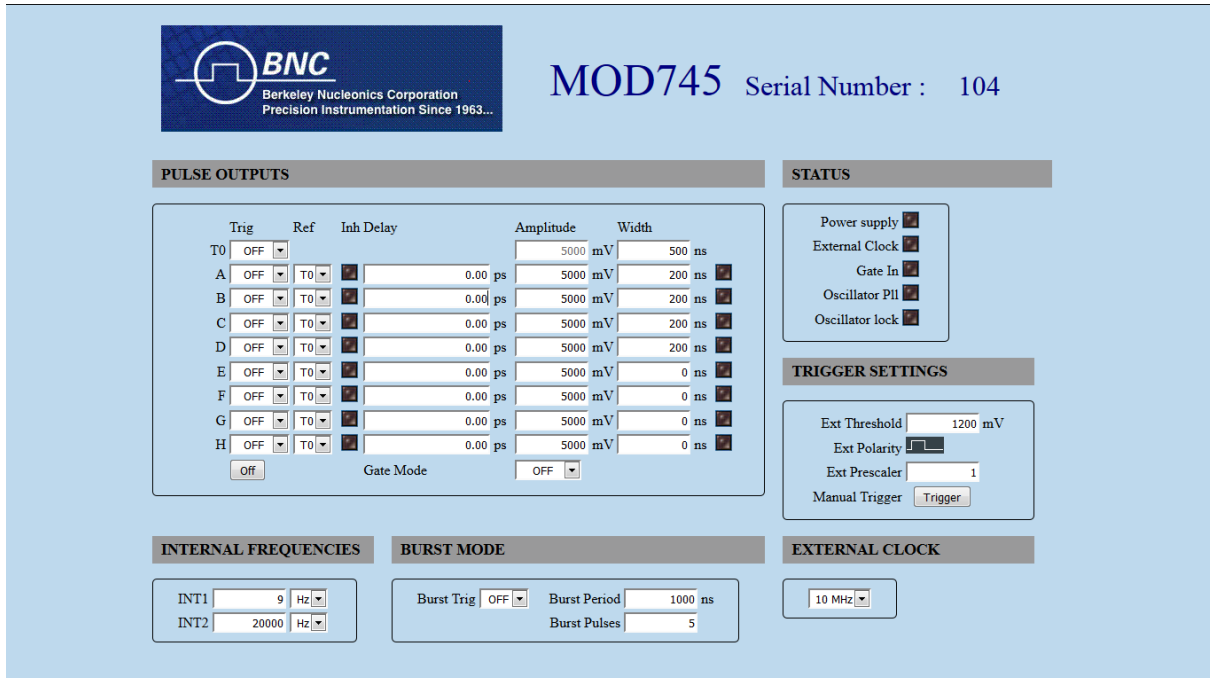

Figure - 16. Configuration page

From that page, the user can configure each output pulse (amplitude, width, trigger, delay, inhibit and delay reference), trigger settings, internal frequencies, external clock and burst mode.

On the first setting change, the user will be asked for Login and Password (Default Login: BNC, Default password: bnc).

Status LEDs indicate which outputs are active or not and Fault LEDs warn the user in case of errors. To refresh led status, the user has to click on one off these LEDs.

The “manual trigger button” is used to trigger a channel sets to SS1, SS2 or LSS (Single shot 1 & 2 and Local Single Shot)

And at last, the user can access to the password setting page by typing in the address field: “Device IP/passwd.htm”.

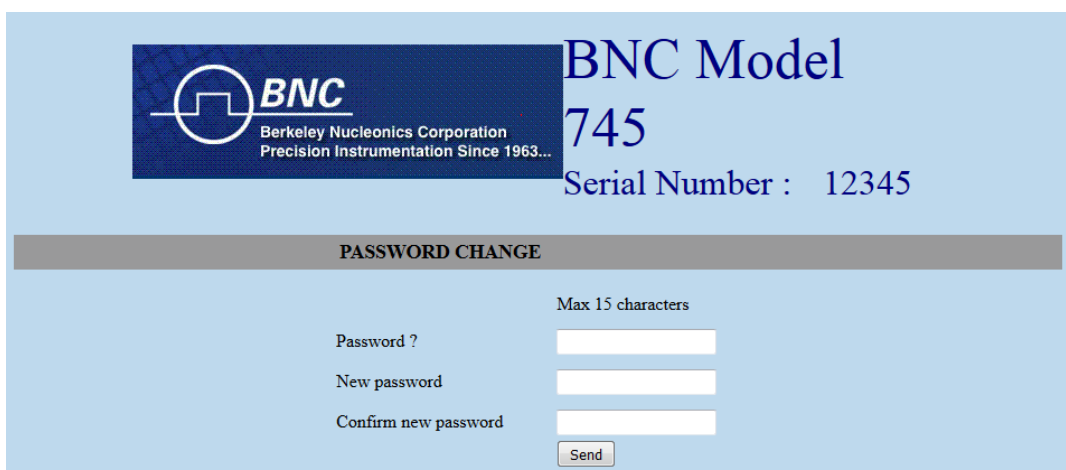

Figure - 17. Password page

9- ANNEX A

High precision and auxiliary pulse results appear on the following figures.

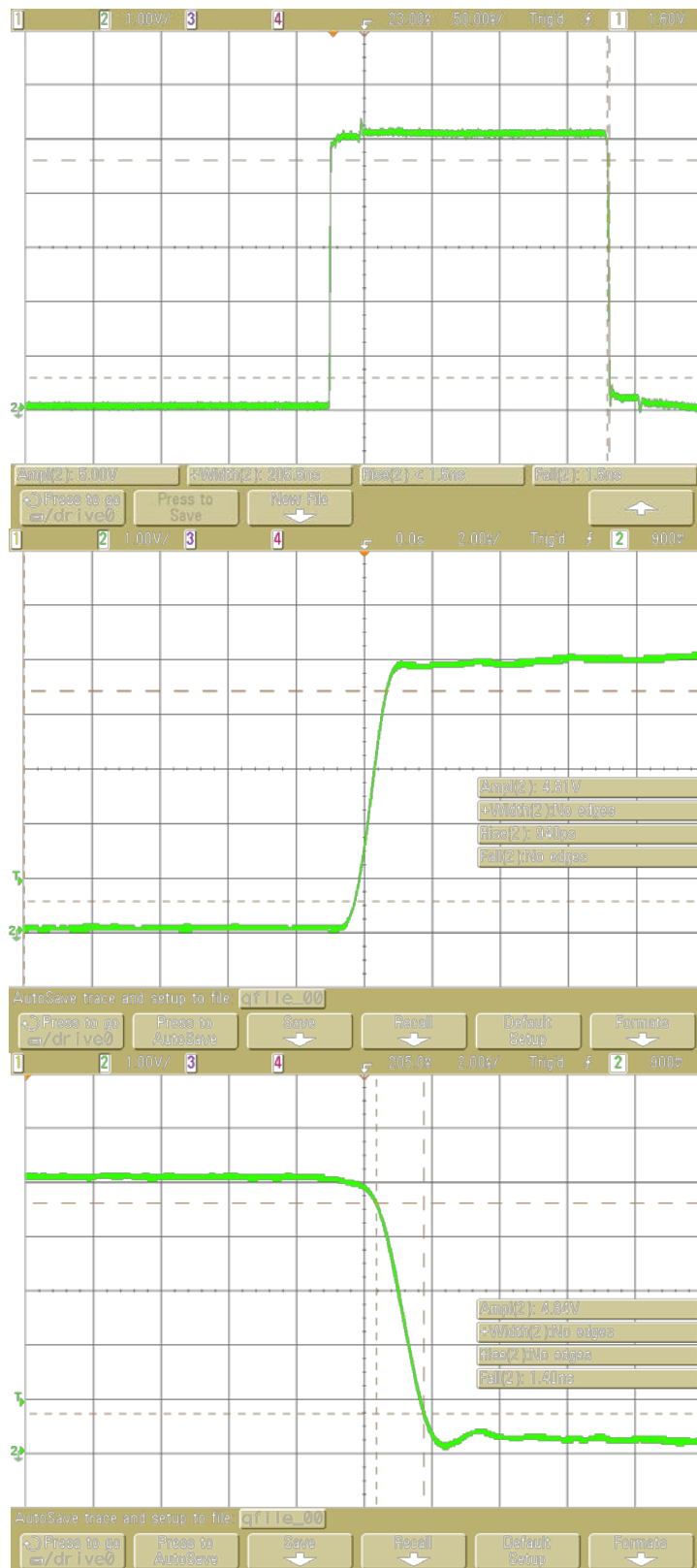

Figure - 18. Main pulse (channels A to D)

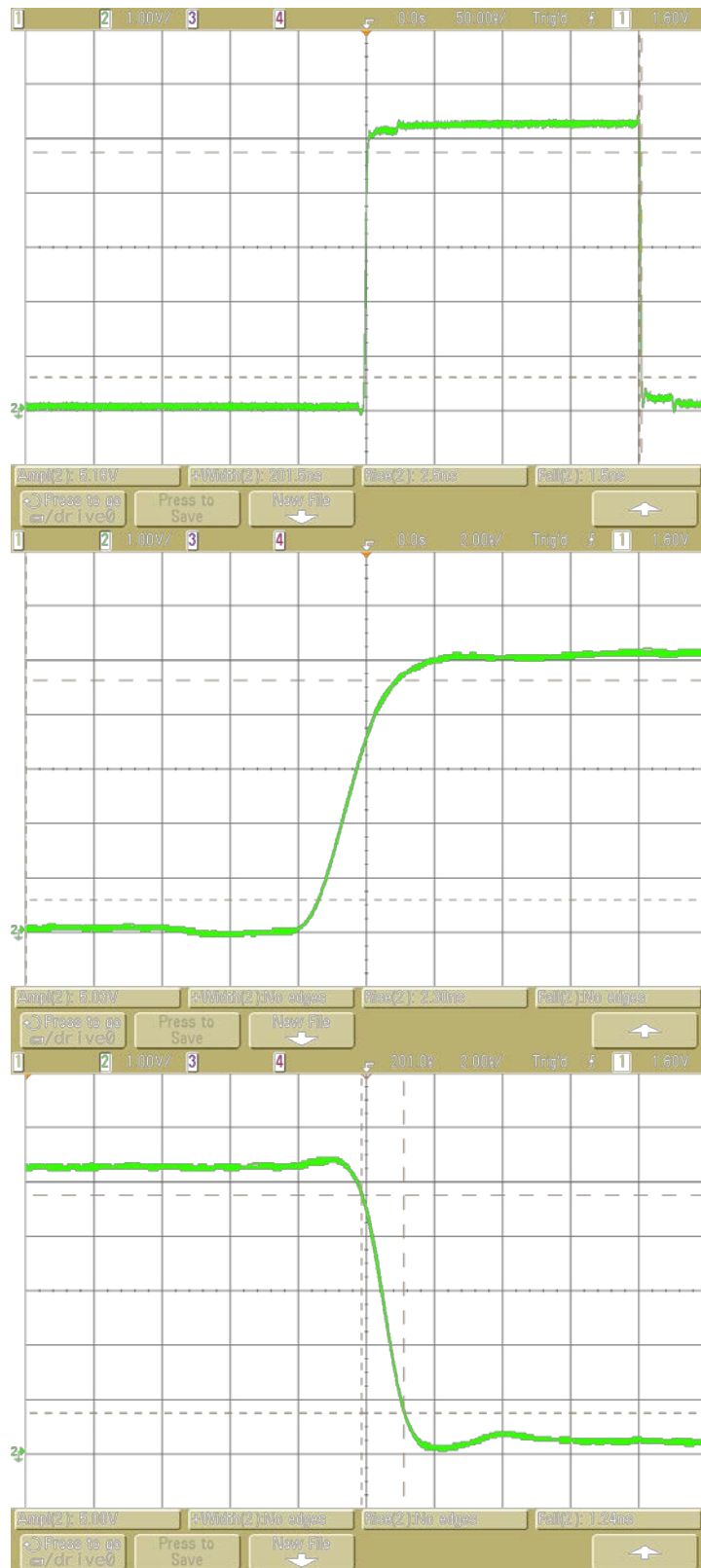

Figure - 19. Auxiliary pulse (channels E to H)

10- ANNEX B

The rms jitter for Internal and External source are depicted on figure 11 and 12. It is given for different delay values.

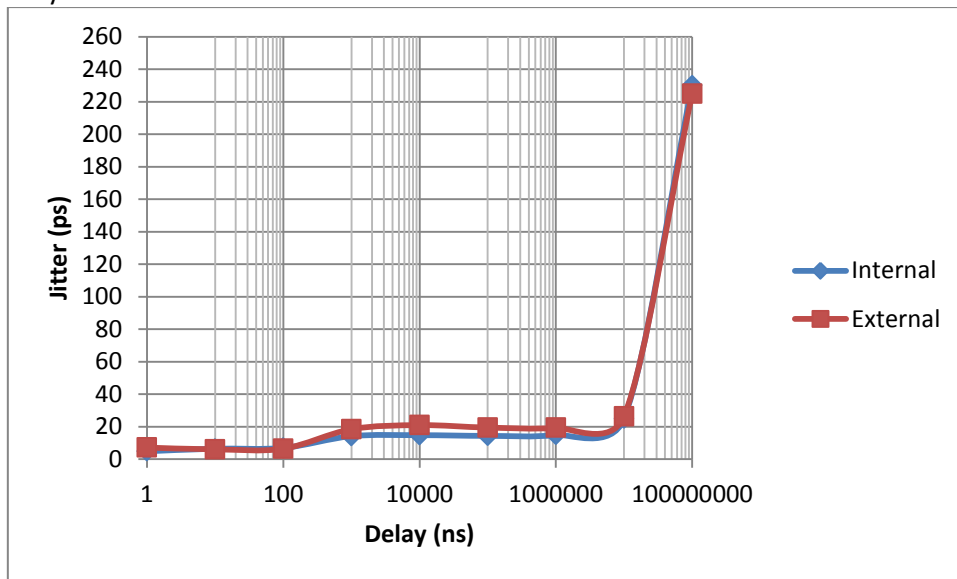

Figure - 20. Internal and External delay Jitter

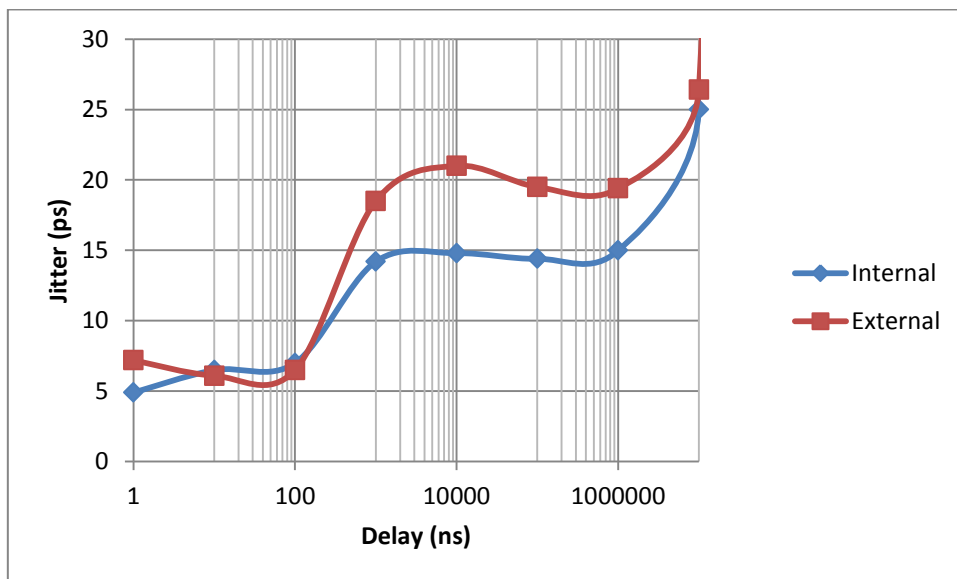

Figure - 21. Zoom on delay jitter

BNC Product Information for People’s Republic of China

This document provides product information as required by the People’s Republic of China Electronic Industry Standard SJ/T11364–2006, *Marking for Control of Pollution Caused by Electronic Information Products*.

Table 1 lists toxic or hazardous substances or elements contained in Berkeley Nucleonics’ electronic information products (EIPs), including subassemblies, that exceed limits specified in SJ/T11363–2006.

Table 1. Example Toxic or Hazardous Substances and Elements Contained in Product

Component Name	Toxic or Hazardous Substances and Elements					
	Lead (Pb)	Mercury (Hg)	Cadmium (Cd)	Hexavalent chromium (Cr ⁶⁺)	Polybrominated biphenyls (PBB)	Polybrominated diphenylethers (PBDE)
Printed circuit card assembly	X	O	O	O	O	O
Metal enclosure	X	O	O	X	O	O

O: Indicates that the toxic or hazardous substance contained in all of the homogeneous materials for this part is below the limit required in SJ/T 11363-2006.

X: Indicates that the toxic or hazardous substance contained in at least one of the homogeneous materials used for this part is above the limit requirement in SJ/T 11363-2006.

Product Marking Explanations

In accordance with the requirements specified in SJ/T 11324-2006, all BNC EIPs sold in the People's Republic of China are marked with pollution control marking. The following marking applies to BNC products.



This marking indicates that some homogeneous substance within the EIP contains toxic or hazardous substances or elements above the requirements listed in SJ/T11363–2006. These substances are identified in Table 1.

The size or function of some products may prevent them from being directly marked. These products still meet SJ/T11364–2006 requirements, and their marking information is covered by this document.

Environmentally Friendly Use Period

The number in the marking, shown as 40 in the illustration above, refers to the EIP’s environmentally friendly use period (EFUP). The EFUP is the number of years from the date of manufacture that toxic

or hazardous substances or elements contained in EIPs will not leak or mutate under the normal operating conditions described in the EIP user documentation, resulting in any environmental pollution, bodily injury, or damage to assets.

Original Equipment Manufactured (OEM) EIP

SJ/T11364–2006 specifies that OEM EIPs shipped by BNC should include hazardous substance information and EFUP markings. Table 1 applies to products that do not supply OEM product information

Manufacture Date

Manufacture dates of all BNC products are encoded into the product serial number. Contact your local sales office to obtain the manufacture date for your product.

Packaging Recycling Marks

EIP packaging is marked in accordance with the needs and requirements for recycling, reuse, and regeneration, as defined in standard GB 18455–2001, *Packaging Recycling Marks*. As specified in SJ/T11364–2006, the following packaging information may be used for instances in which it is not possible to provide recycling marks on the packaging material.

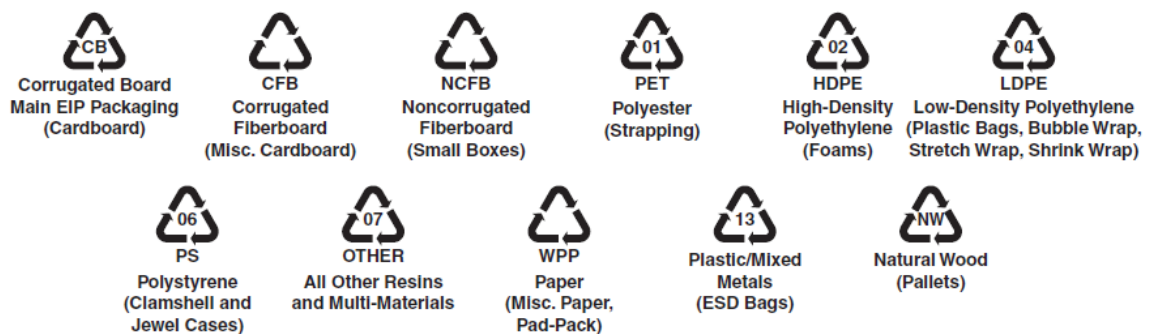

Waste Electrical and Electronic Equipment (WEEE)

EU Customers At the end of the product life cycle, all products must be sent to a WEEE recycling center.

Restriction of Hazardous Substance (RoHS)